

NANO

4

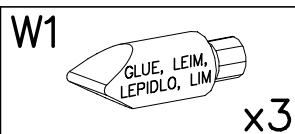
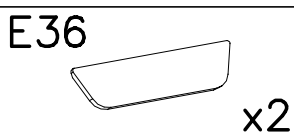
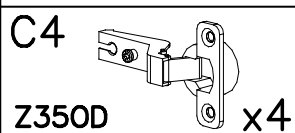
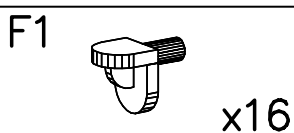
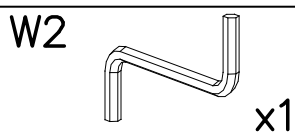
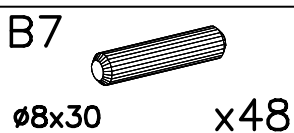
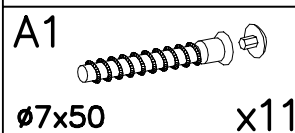
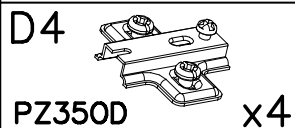
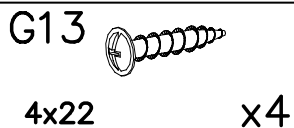
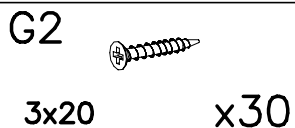
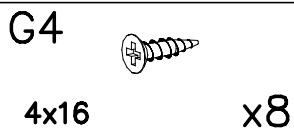
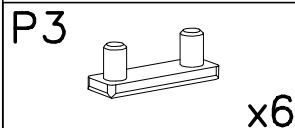
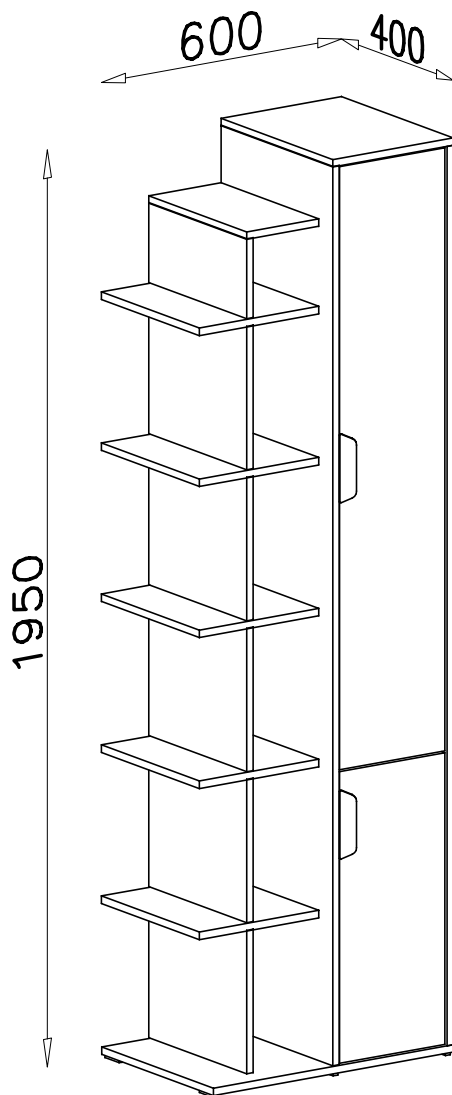
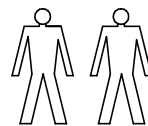
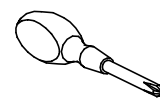
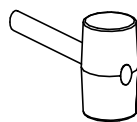
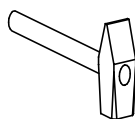
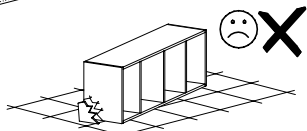
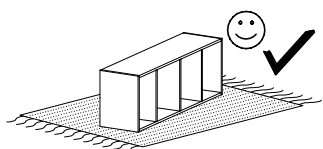

I

B7

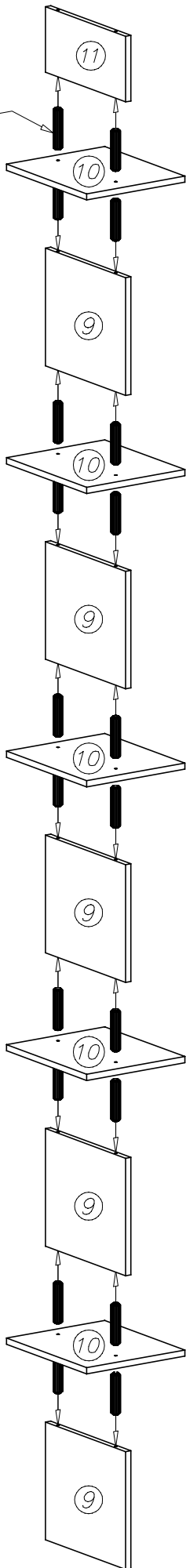

II

A1

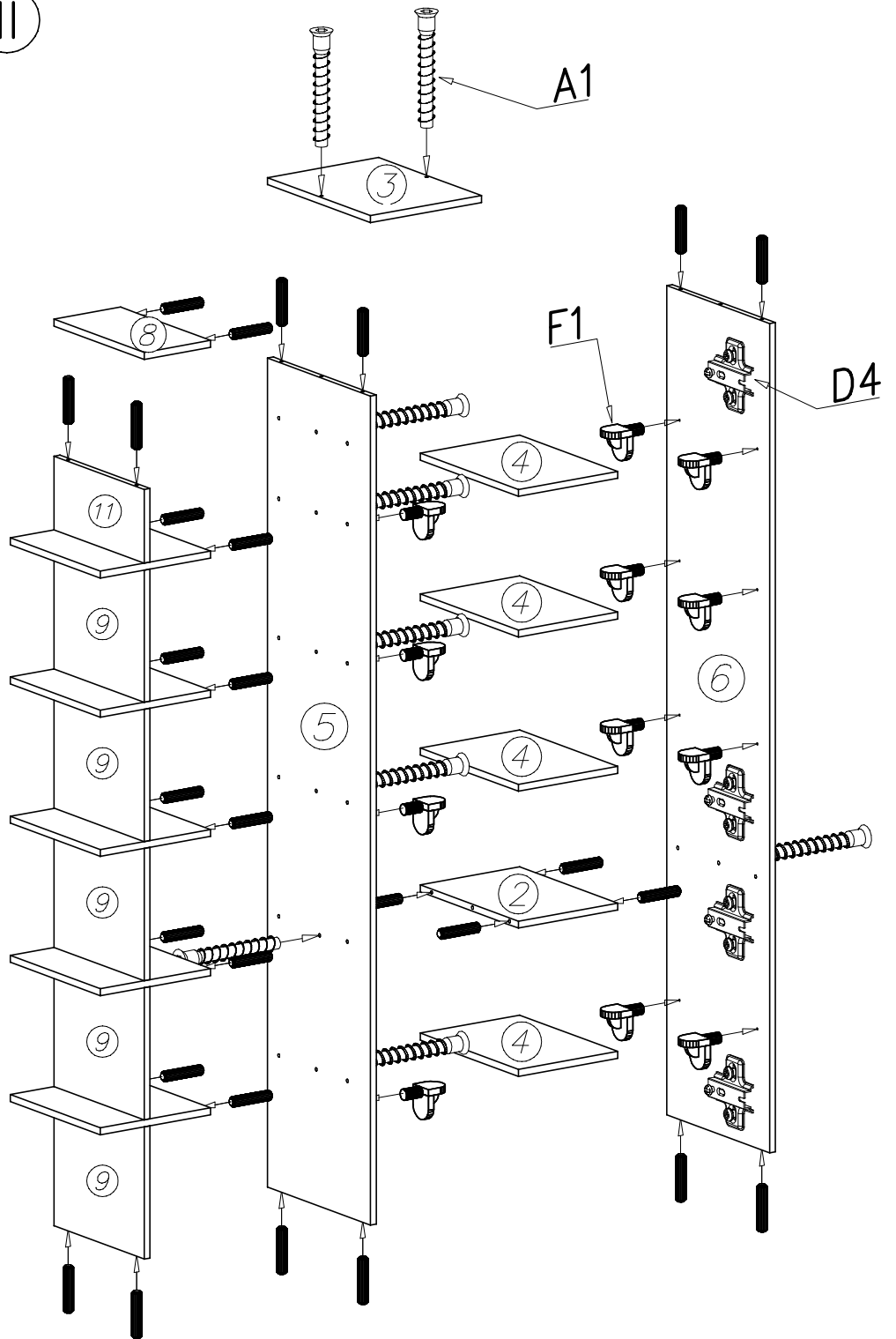

P3

A1

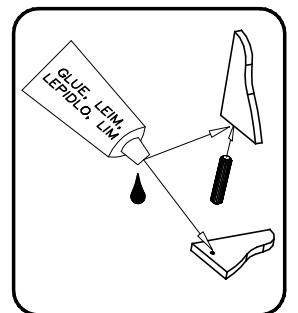
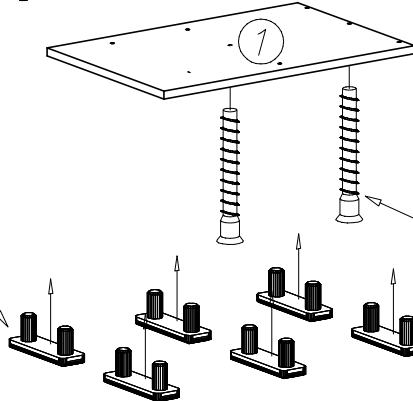

III

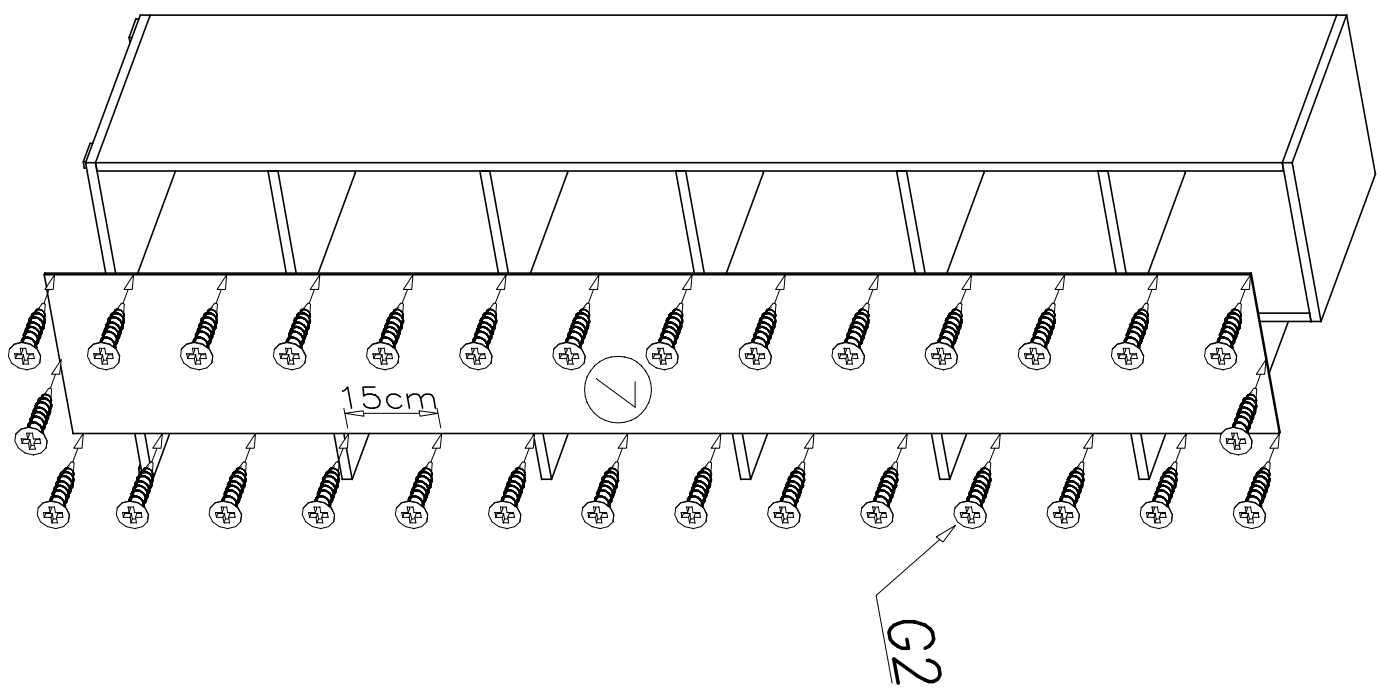

IV

